

Fexa®

Mampara de baño corrediza / Perfiles escala 1:1

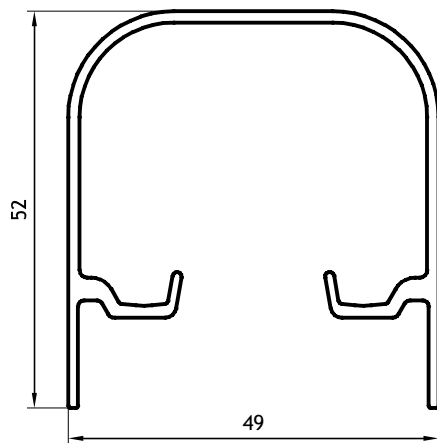

Cabezal
 0,749 Kg/m
 00551
 Barras de 6.05m
 6 Barras por Paquete

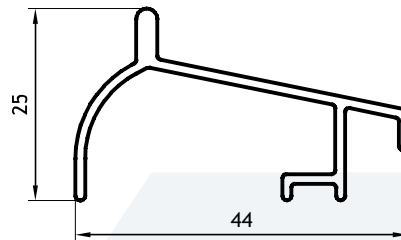

Umbral Sanitario
 0,343 Kg/m
 00552
 Barras de 6.05m
 12 Barras por Paquete

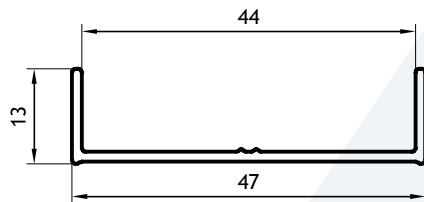

Jamba
 0,248 Kg/m
 00553
 Barras de 6.05m
 10 Barras por Paquete

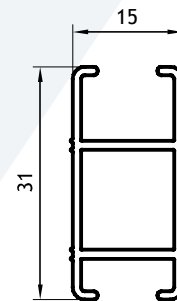

Hoja
 0,290 Kg/m
 00554
 Barras de 6.05m
 12 Barras por Paquete

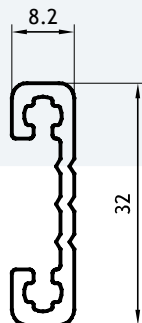

Toallero
 0,300 Kg/m
 00555
 Barras de 6.05m

Mampara de baño corrediza / Planilla de cortes y descuentos

Perfiles

Código	Descripción	Cantidad	Largo	Corte	Corte	Opciones
00551	Cabezal	1	a	90.00°	90.00°	
00552	Umbral sanitario	1	a-3mm	90.00°	90.00°	
00553	Jamba	2	h-41mm	90.00°	90.00°	
00554	Hoja	4	h-79mm	45.00°	45.00°	
00554	Hoja	4	a/2+9mm	45.00°	45.00°	

Accesorios

Código	Descripción	Cantidad
70056	Burlete Acrílico Mampara (GG)	4
70057	Burlete Tope Mampara (HH)	4
70251	Escuadra 13mm 22mm (Parte B)	8
70550	Kit de armado mampara corrediza	1

Vidrios

Espesores	Cant.	Largo
3 a 6 mm	1	(a/2-35mm) + (h-123mm)

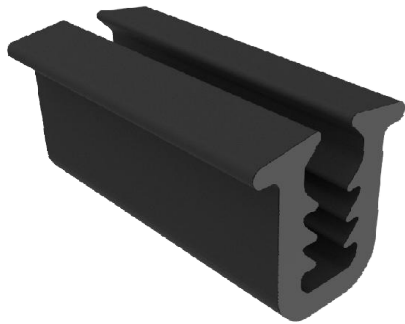

70056
Burlete Acrílico Mampara (GG)
x 100 metros

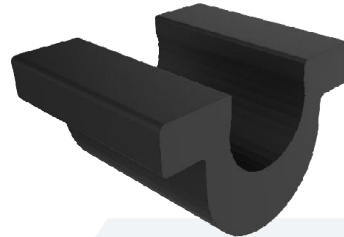

70057
Burlete Tope Mampara
x 100 metros

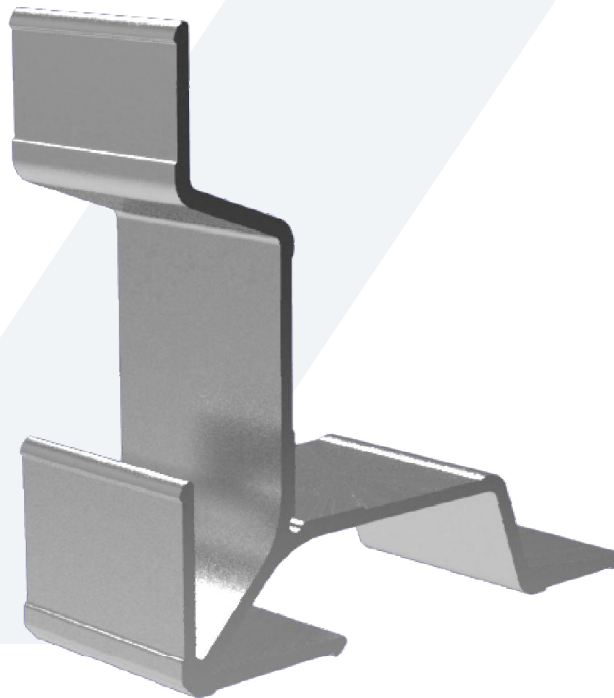

70251
Escuadra 13mm (Parte B) 22mm
x 100 unidades



70245
 Patín inferior Chico de Mampara (2
 unidades en 70550) (R/2)
 x 100 unidades

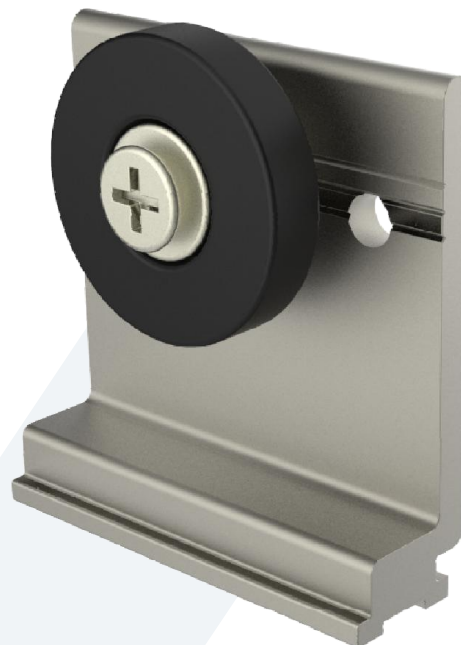

70246
 Conjunto 4/R Mampara con rulemán
 (4 unidades en 70550)
 x 40 unidades



70263
 Patín grande Mampara (R/3)
 (2 unidades en 70550)
 x 50 unidades



70252
 Patín regulador Mampara (AEI/R-18)
 (4 unidades en 70550)
 x 100 unidades

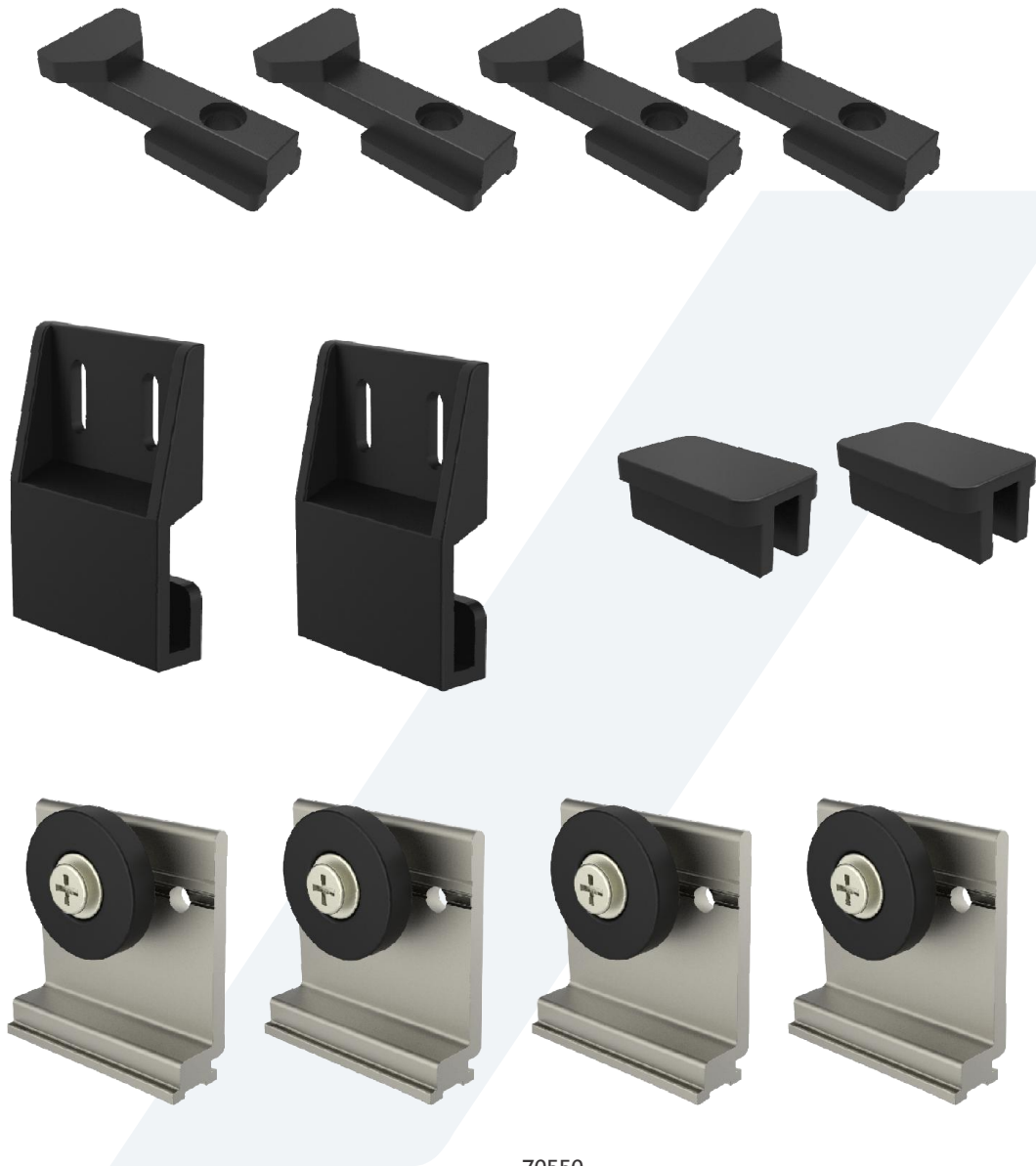

70550
Kit de armado Mampara (2x70245 +
2x70263 + 4x70252 + 4x70246)
x unidad